



Report

US \$44.99

2016 Volvo XC90 T6 R-Design

131,090 mi | VIN: YV4A22PM7G1055145 |

4 Door Wagon/Sport Utility | 2.0L I4 F DOHC 16V | Gasoline | All wheel drive

CARFAX HAS THE MOST ACCIDENT & DAMAGE INFORMATION



BRANDED TITLE



Salvage



29 Service history records



3 Previous owners



Personal vehicle



Last owned in Georgia



54 Detailed records available

This CARFAX Vehicle History Report is based only on information supplied to CARFAX and available as of 3/20/26 at 3:59:12 AM (CDT). Other information about this vehicle, including problems, may not have been reported to CARFAX. Use this report as one important tool, along with a vehicle inspection and test drive, to make a better decision about your next used car.



Accident / Damage History

Not all accidents / issues are reported to CARFAX

Event 1

02/07/2019

Accident reported

- Vehicle involved in a rear-end collision
- Functional damage reported
- Airbags did not deploy

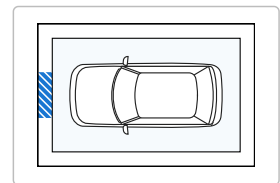

Event 2

02/28/2020

Accident reported: minor to moderate damage

- Vehicle involved in a sideswipe collision
- Functional damage reported
- Airbags did not deploy

Damage Severity Scale

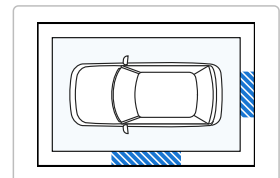

Event 3

12/09/2025

Accident reported: minor damage

Damage Severity Scale

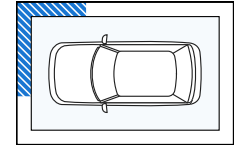
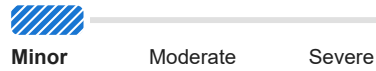

Event 4

02/20/2026

TOTAL LOSS VEHICLE



Recent Service Highlights

Key services performed in the last 12 months

Service	Comments	Date
Oil	✓ Oil and filter changed	09/23/2025
Tires	✓ Four wheel alignment performed	06/20/2025
Brakes	✓ Brake fluid flushed/changed ✓ Front brake pads replaced ✓ Front brake rotor(s) replaced	10/27/2025
Flushes ⓘ	✓ Antifreeze/coolant flushed/changed	10/27/2025







This car has been recently serviced. That's a good thing!



Additional History



Not all accidents / issues are reported to CARFAX

	👤 Owner 1	👤 Owner 2	👤 Owner 3
Total Loss Total Loss Reported: 02/20/2026.	✓ No Issues Reported	✓ No Issues Reported	Total Loss Reported
Structural Damage CARFAX recommends that you have this vehicle inspected by a collision repair specialist.	✓ No Issues Reported	✓ No Issues Reported	✓ No Issues Reported
Airbag Deployment No airbag deployment reported to CARFAX.	✓ No Issues Reported	✓ No Issues Reported	✓ No Issues Reported
Odometer Check No indication of an odometer rollback.	✓ No Issues Indicated	✓ No Issues Indicated	✓ No Issues Indicated
Accident / Damage DMV title problems reported. Accidents reported: 02/07/2019, 02/28/2020, and 12/09/2025.	Accident Reported	No New Issues Reported	Severe Damage
Manufacturer Recall No open recalls reported to CARFAX.	✓ No Recalls Reported	✓ No Recalls Reported	✓ No Recalls Reported
Basic Warranty Original manufacturer warranty likely voided by manufacturer.	✓ Warranty Active	✓ Warranty Active	Warranty Voided

 Title History	 Owner 1	 Owner 2	 Owner 3
Damage Brands Salvage Junk Rebuilt Fire Flood Hail Lemon	No Problem	No Problem	Alert! Problem Found
Odometer Brands Not Actual Mileage Exceeds Mechanical Limits	No Problem	No Problem	No Problem

 **ALERT!** - Severe problems were reported by a state Department of Motor Vehicles (DMV). This vehicle does not qualify for the CARFAX Buyback Guarantee.

 Ownership History	 Owner 1	 Owner 2	 Owner 3
The number of owners is estimated			
Year purchased	2016	2025	2025
Type of owner	Personal	Personal	Personal
Estimated length of ownership	9 yrs. 4 mo.	1 month	6 months
Owned in the following states/provinces	Georgia	Georgia	Georgia
Estimated miles driven per year	13,229/yr	---	---
Last reported odometer reading	124,213	128,038	131,090

 Detailed History			
 Owner 1 Purchased: 2016		Personal Vehicle 13,229 mi/yr	
Date	Mileage	Source	Comments
12/03/2015		Volvo Cars of North America, LLC	Vehicle manufactured
12/30/2015		Volvo Motors	Vehicle shipped to original dealer in Atlanta, GA
02/01/2016		Georgia Motor Vehicle Dept.	Vehicle purchase reported - Titled or registered as personal vehicle
02/01/2016	28	Warrantech Automotive, Inc. Atlanta, GA warrantech.com	Service contract issued
02/17/2016		Georgia Motor Vehicle Dept. Toccoa, GA Title #773353160488963	Vehicle purchase reported - Title issued or updated - Registration issued or renewed - Title or registration issued - First owner reported - Loan or lien reported - Vehicle color noted as Red
05/28/2016		Georgia Motor Vehicle Dept. Toccoa, GA Title #773353160488963	Registration issued or renewed - Loan or lien reported - Vehicle color noted as Red
05/13/2017		Georgia Motor Vehicle Dept. Toccoa, GA Title #773353160488963	Registration issued or renewed - Loan or lien reported - Vehicle color noted as Red
06/01/2017	21,497	Dyer & Dyer Volvo, Inc. Atlanta, GA 770-452-0077 dyervolvocars.com/	 Vehicle serviced - Recommended maintenance performed - Rear brake pads replaced - Tire condition and pressure checked

-Vehicle washed/detailed

03/29/2018 32,953 Dyer & Dyer Volvo, Inc.
Atlanta, GA
770-452-0077
dyervolvocars.com/



Vehicle serviced
-Recommended maintenance performed
-Windshield replaced
-Vehicle washed/detailed

05/14/2018 Georgia
Motor Vehicle Dept.
Toccoa, GA
Title #773353160488963

Registration issued or renewed
-Loan or lien reported
-Vehicle color noted as Red

07/18/2018 38,213 Dyer & Dyer Volvo, Inc.
Atlanta, GA
770-452-0077
dyervolvocars.com/



Vehicle serviced
-Battery replaced
-Engine/powertrain computer/module reprogrammed
-Vehicle washed/detailed

09/08/2018 41,445 Dyer & Dyer Volvo, Inc.
Atlanta, GA
770-452-0077
dyervolvocars.com/



Vehicle serviced
-Four tires balanced
-Four tires mounted
-Tire(s) replaced
-Vehicle washed/detailed

01/11/2019 48,385 Dyer & Dyer Volvo, Inc.
Atlanta, GA
770-452-0077
dyervolvocars.com/



Vehicle serviced
-40,000 mile service performed
-Front brake pads replaced
-Rear brake pads replaced
-Vehicle washed/detailed

02/07/2019 Damage Report



Accident reported
-Vehicle involved in a rear-end collision
-Damage to front
-Functional damage reported
-Airbags did not deploy

**CARFAX HAS THE MOST
ACCIDENT & DAMAGE
INFORMATION**

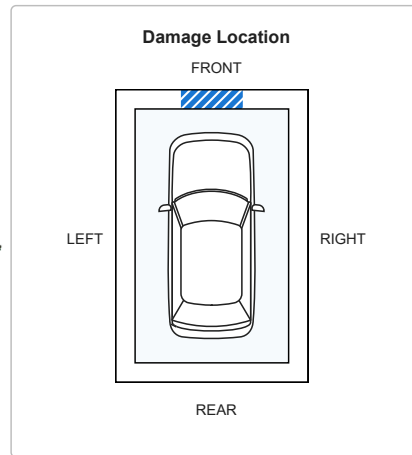

03/26/2019 49,420 Dyer & Dyer Volvo, Inc.
Atlanta, GA
770-452-0077
dyervolvocars.com/



Vehicle serviced

03/27/2019 Global Imports MINI
Chamblee, GA
678-569-7550
atlantamini.com/



Vehicle serviced

04/20/2019 Georgia
Motor Vehicle Dept.
Toccoa, GA
Title #773353160488963

Registration issued or renewed
-Loan or lien reported
-Vehicle color noted as Red

07/23/2019 54,277 Dyer & Dyer Volvo, Inc.
Atlanta, GA
770-452-0077
dyervolvocars.com/



Vehicle serviced
-Tire(s) replaced
-Vehicle washed/detailed

12/10/2019

Dyer & Dyer Volvo, Inc.
Atlanta, GA
770-452-0077
dyervolvocars.com/



Vehicle serviced

- 60,000 mile service performed
- Four wheel alignment performed
- Tire(s) replaced
- Two tires mounted
- Two tires replaced
- Vehicle washed/detailed

02/28/2020

Damage Report



Accident reported: minor to moderate damage

- Vehicle involved in a sideswipe collision
- Damage to left side
- Damage to rear
- Functional damage reported
- Airbags did not deploy

CARFAX HAS THE MOST ACCIDENT & DAMAGE INFORMATION



Damage Severity Scale



Damage Location

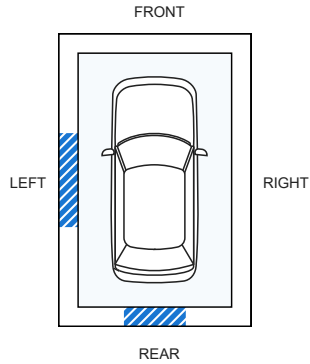

03/19/2020

54,688

Global Imports MINI
Chamblee, GA
678-569-7550
atlantamini.com/



Vehicle serviced

- Maintenance inspection completed
- Alignment performed
- One tire balanced
- One tire mounted
- Tire(s) balanced
- Tire(s) mounted
- Vehicle washed/detailed

04/19/2020

Georgia
Motor Vehicle Dept.
Toccoa, GA
Title #773353160488963

Title or registration issued

- Loan or lien reported
- Vehicle color noted as Red

07/10/2020

55,001

Global Imports MINI
Chamblee, GA
678-569-7550
atlantamini.com/



Vehicle serviced

07/13/2020

67,914

Warrantech Automotive, Inc.
warrantech.com



Service contract claim

- Supercharger serviced

07/20/2020

67,918

Dyer & Dyer Volvo, Inc.
Atlanta, GA
770-452-0077
dyervolvocars.com/



Vehicle serviced

- Engine checked

09/01/2020

69,247

Warrantech Automotive, Inc.
warrantech.com



Service contract claim

- Electrical sys. serviced

09/04/2020











69,248







Dyer & Dyer Volvo, Inc.
Atlanta, GA
770-452-0077
dyervolvocars.com/



Vehicle serviced

- Vehicle washed/detailed

11/30/2020	75,447	Dyer & Dyer Volvo, Inc. Atlanta, GA 770-452-0077 dyervolvocars.com/		Vehicle serviced -70,000 mile service performed -Vehicle washed/detailed
03/04/2021		Georgia Motor Vehicle Dept. Title #770067269761962		Vehicle purchase reported -Title issued or updated
04/24/2021		Georgia Motor Vehicle Dept. Toccoa, GA Title #770067269761962		Registration issued or renewed -Vehicle color noted as Red
05/06/2021	82,620	Gordy Tire Co Atlanta, GA 404-355-0118		Vehicle serviced -Tire repaired
09/17/2021	88,875	Dyer & Dyer Volvo, Inc. Atlanta, GA 770-452-0077 dyervolvocars.com/		Vehicle serviced -80,000 mile service performed -Brake fluid flushed/changed -Front brake pads replaced -Fuse(s) replaced -Rear brake pads replaced -Vehicle washed/detailed
01/05/2022	92,182	Warrantech Automotive, Inc. warrantech.com		Service contract claim
01/07/2022		Dyer & Dyer Volvo, Inc. Atlanta, GA 770-452-0077 dyervolvocars.com/		Vehicle serviced -Four tires balanced -Four tires mounted -Four wheel alignment performed -Front wiper blades/refills replaced -Oil and filter changed -Vehicle washed/detailed
01/14/2022	92,247	Dyer & Dyer Volvo, Inc. Atlanta, GA 770-452-0077 dyervolvocars.com/		Vehicle serviced -Vehicle washed/detailed
06/07/2022		Georgia Motor Vehicle Dept. Toccoa, GA Title #770067269761962		Registration issued or renewed -Vehicle color noted as Red
12/02/2022	107,222	Jack Ingram Volvo Montgomery, AL 334-420-7701 jackingramvolvocars.com		Vehicle serviced -Maintenance inspection completed -Cooling system checked -Drivability/performance checked -Thermostat replaced
12/14/2022	107,301	Dyer & Dyer Volvo, Inc. Atlanta, GA 770-452-0077 dyervolvocars.com/		Vehicle serviced -Vehicle washed/detailed
02/17/2023	107,391	Georgia Inspection Station		Passed emissions inspection
11/16/2023	111,493	Volvo Cars of Marietta Marietta, GA 877-806-8865 https://volvocarsofmarietta.com/?ddcref=yextgmb		Vehicle serviced -Maintenance inspection completed -Fuel injection system flushed/serviced -Fuel system cleaned/serviced -Oil and filter changed
10/31/2024	117,662	Volvo Cars of Marietta Marietta, GA 877-806-8865 https://volvocarsofmarietta.com/?ddcref=yextgmb		Vehicle serviced -Maintenance inspection completed -Fuel injection system flushed/serviced -Fuel system cleaned/serviced -Oil and filter changed
06/10/2025		Georgia Motor Vehicle Dept.		Vehicle purchase reported

06/20/2025	124,213	Williams Tire Blue Ridge Blue Ridge, GA 706-946-2322		Vehicle serviced -Four wheel alignment performed
 Owner 2 Purchased: 2025				Personal Vehicle
Date	Mileage	Source	Comments	
06/30/2025		Georgia Motor Vehicle Dept. Blue Ridge, GA Title #770237282805965	Title or registration issued -New owner reported -Vehicle color noted as Red	
08/01/2025	128,038	Williams Tire Blue Ridge Blue Ridge, GA 706-946-2322		Vehicle serviced
 Owner 3 Purchased: 2025				Personal Vehicle
Date	Mileage	Source	Comments	
08/19/2025		Georgia Motor Vehicle Dept.	Vehicle purchase reported	
08/23/2025		Georgia Motor Vehicle Dept. Mineral Bluff, GA Title #770245266453069	Title or registration issued -New owner reported -Vehicle color noted as Red	
09/23/2025	129,799	Volvo Cars of Marietta Marietta, GA 877-806-8865 https://volvocarsofmarietta.com/?ddcref=yextgmb		Vehicle serviced -Maintenance inspection completed -Antifreeze/coolant flushed/changed -Battery cable(s) replaced -Fuel injection system flushed/serviced -Fuel system cleaned/serviced -Oil and filter changed
10/27/2025	129,966	Mountain European Auto Repair Blairsville, GA 706-400-5515 mountain-european-auto-repair.business.site/		Vehicle serviced -Air filter replaced -Antifreeze/coolant flushed/changed -Brakes checked -Brake fluid flushed/changed -Cabin air filter replaced/cleaned -Crankshaft oil seal(s) replaced -Engine mount(s) replaced -Front brake pads replaced -Front brake rotor(s) replaced -Ignition coil(s) replaced -PCV valve replaced -Spark plug(s) replaced -Timing belt replaced -Timing belt tensioner/idler replaced
12/09/2025		Damage Report	Accident reported: minor damage -Damage to front -Damage to right front	
<div data-bbox="850 1661 1256 1812" data-label="Figure"> <p>Damage Severity Scale</p>  <p>Minor Moderate Severe</p> </div>				

CARFAX HAS THE MOST ACCIDENT & DAMAGE INFORMATION

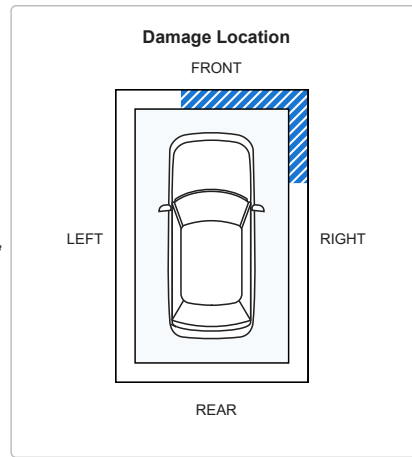

02/17/2026		Georgia Motor Vehicle Dept.		Vehicle purchase reported
02/20/2026		Damage Report		TOTAL LOSS VEHICLE
				<div style="border: 1px solid blue; padding: 5px;"> <p>There are many reasons an insurance company will declare a vehicle a total loss. Have this vehicle inspected by a qualified technician before you buy. Learn More</p> </div>
02/20/2026		Georgia Motor Vehicle Dept.		Title or registration issued to insurance company
02/20/2026	131,090	Georgia Motor Vehicle Dept. Cleveland, OH Title #400265207660964		SALVAGE TITLE/CERTIFICATE ISSUED -Vehicle color noted as Red

Have Questions? Consumers, please visit our Help Center at www.carfax.com. Dealers or Subscribers, please visit our Help Center at www.carfaxonline.com.

Glossary

Accident Indicator

CARFAX receives information about accidents in all 50 states, the District of Columbia and Canada.

Not every accident is reported to CARFAX. As details about the accident become available, those additional details are added to the CARFAX Vehicle History Report. CARFAX recommends that you have this vehicle inspected by a qualified mechanic.

- According to the National Safety Council, Injury Facts, 2021 edition, 5% of the 276 million registered vehicles in the U.S. were involved in an accident in 2019. Over 77% of these were considered minor or moderate.
- This CARFAX Vehicle History Report is based only on information supplied to CARFAX and available as of 3/20/26 at 3:59:12 AM (CDT). Other information about this vehicle, including problems, may not have been reported to CARFAX. Use this report as one important tool, along with a vehicle inspection and test drive, to make a better decision about your next used car.

Damage Indicator

Damage can be a result of many different types of events. Examples include contact with objects (other cars, trees, traffic signs, road debris, etc), vandalism, or weather-related events. Not every damage event is reported to CARFAX. As details about the damage event become available, those additional details are added to the CARFAX Vehicle History Report. CARFAX recommends that you have this vehicle inspected by a qualified mechanic.

- This CARFAX Vehicle History Report is based only on information supplied to CARFAX and available as of 3/20/26 at 3:59:12 AM (CDT). Other information about this vehicle, including problems, may not have been reported to CARFAX. Use this report as one important tool, along with a vehicle inspection and test drive, to make a better decision about your next used car.

Damage Severity

Damage events result in one of the following severity levels:

- Minor: Generally, minor damage is cosmetic (including dents or scratches), may only require reconditioning, and typically does not compromise a vehicle's operation and/or safety.
- Moderate: Moderate damage may affect multiple components of the vehicle and may impair the vehicle's operation and/or safety.
- Severe: Severe damage usually affects multiple components of the vehicle and is likely to compromise the vehicle's operation and/or safety.

CARFAX recommends getting a pre-purchase inspection at a certified collision repair facility.

First Owner

When the first owner(s) obtains a title from a Department of Motor Vehicles as proof of ownership.

New Owner Reported

When a vehicle is sold to a new owner, the Title must be transferred to the new owner(s) at a Department of Motor Vehicles.

Ownership History

CARFAX defines an owner as an individual or business that possesses and uses a vehicle. Not all title transactions represent changes in ownership. To provide estimated number of owners, CARFAX proprietary technology analyzes all the events in a vehicle history. Estimated ownership is available for vehicles manufactured after 1991 and titled solely in the US including Puerto Rico. Dealers sometimes opt to take ownership of a vehicle and are required to in the following states: Maine, Massachusetts, New Jersey, Ohio, Oklahoma, Pennsylvania and South Dakota. Please consider this as you review a vehicle's estimated ownership history.

Salvage Title

A Salvage Title is issued on a vehicle damaged to the extent that the cost of repairing the vehicle exceeds approximately 75% of its pre-damage value. This damage threshold may vary by state. Some states treat Junk titles the same as Salvage but the majority use this title to indicate that a vehicle is not road worthy and cannot be titled again in that state. The following eleven states also use Salvage titles to identify stolen vehicles - AZ, FL, GA, IL, MD, MN, NJ, NM, NY, OK and OR.

Title Issued

A state issues a title to provide a vehicle owner with proof of ownership. Each title has a unique number. Each title or registration record on a CARFAX report does not necessarily indicate a change in ownership. In Canada, a registration and bill of sale are used as proof of ownership.

Total Loss Vehicle

An insurance or fleet company declares a vehicle a total loss when a claim exceeds approximately 75% of its pre-damage value or if the vehicle is stolen and not recovered. This damage threshold varies by company. These companies typically take possession and obtain the title. Not all total loss vehicles result in a DMV-reported branded title. This may occur when an insurance company's definition of a total loss is different than the state DMV's definition for a branded title or when the owner of the vehicle is a self-insured company, like a fleet or rental company.

Follow Us:



facebook.com/CARFAX



[@CARFAXinc](https://twitter.com/CARFAXinc)



[About CARFAX](#)

CARFAX DEPENDS ON ITS SOURCES FOR THE ACCURACY AND RELIABILITY OF ITS INFORMATION. THEREFORE, NO RESPONSIBILITY IS ASSUMED BY CARFAX OR ITS AGENTS FOR ERRORS OR OMISSIONS IN THIS REPORT. CARFAX FURTHER EXPRESSLY DISCLAIMS ALL WARRANTIES, EXPRESS OR IMPLIED, INCLUDING ANY IMPLIED WARRANTIES OF MERCHANTABILITY OR FITNESS FOR A PARTICULAR PURPOSE.

© 2026 CARFAX, Inc., part of S&P Global. All rights reserved.
3/20/26 3:59:12 AM (CDT)

I have reviewed and received a copy of the CARFAX Vehicle History Report for this 2016 VOLVO XC90 vehicle (VIN: YV4A22PM7G1055145), which is based on information supplied to CARFAX and available as of 3/20/26 at 4:59 AM (EDT).

Customer Signature

Date

Dealer Signature

Date